

Service Trolleys

Three Tier Service Trolley with Handle 900 mm

ITEM # _____

MODEL # _____

NAME # _____

SIS # _____

AIA # _____



361206 (STR903WH)

3-tier Service Trolley with handle 900mm

Short Form Specification

Item No. _____

Constructed in 304 AISI stainless steel. Framework in mm25 tubing, completely welded. Seamless, sound-absorbing, shelves with double-folded edges. Shelves are welded to the framework. The handles are an extension of the load-bearing frame. N. 4 swivelling castors, two with brakes, mm125 in diameter, fitted with plastic bumpers. Shelves size mm900x600. Load capacity: 100 kg, uniformly distributed.

Main Features

- Framework in 25 mm tubing, completely welded.
- Load capacity of 100 kg uniformly distributed.
- Seamless sound-absorbing shelves with double-folded edges welded to the framework.
- Shelves size 900x600 mm.
- Strong, ergonomic handle is an extension of the load-bearing frame.
- 4 pivoting Ø 125 mm wheels, 2 of which with brakes, fitted with plastic bumpers

Construction

- Constructed entirely in 304 AISI stainless steel.

APPROVAL: _____

Key Information:

External dimensions, Width:	995 mm
361206 (STR903WH)	
External dimensions, Depth:	695 mm
External dimensions, Height:	916 mm
Wheel material:	Zinc plated
Wheel diameter:	Ø 125
Net weight:	30 kg

Front

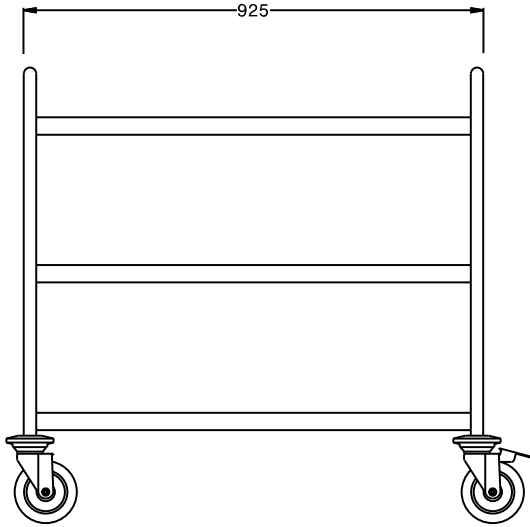

Side

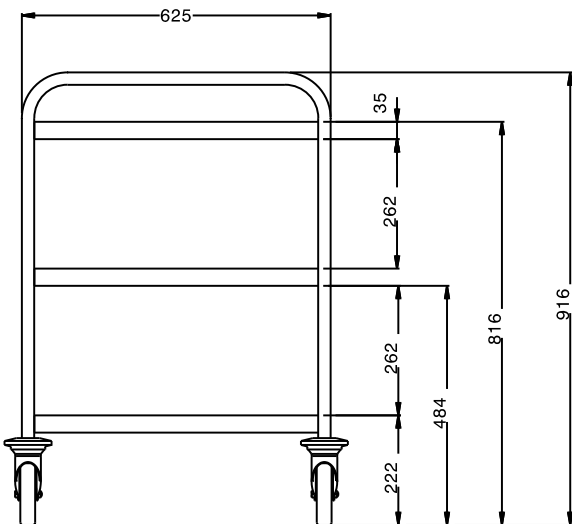

Top

